



Solstart

Analog Soft Starter
8-58A, 220-600V



Instruction Manual

Ver. 26/02/2009

SOLSTART Instruction Manual

1. TABLE OF CONTENT

1.	Table of Content	2
2.	Safety & Warnings	3
2.1	Safety	3
2.2	Attention	3
2.3	Warnings	3
3.	Technical Data	4
3.1	Introduction	4
3.2	Rating and frames sizes	4
3.3	Starter Selection	4
3.4	Mains and control description	5
3.4.1	Mains Voltage (line to line) (Terminals/bars L1, L2, L3)	5
3.4.2	Start/Stop (Terminals A1,A2)	5
3.4.3	End Of Acceleration (terminals 3, 4) Solstart 31A and up	5
3.5	Built-in Bypass	5
3.6	Starter selection tables for various voltage ratings.	6
3.6.1	Ordering Information	6
4.	Recommended Wiring Schemes	7
4.1	Typical wiring diagram	7
4.2	Wiring Notes	7
4.2.1	Short Circuit Protection	8
4.2.2	Transient Protection	8
5.	Dimensions	9
6.	Installation	10
6.1	Prior to Installation	10
6.2	Mounting	10
6.3	Temperature range & heat dissipation	10
6.3.1	Calculating the enclosure size, for non-ventilated metallic enclosure	10
6.3.2	Additional Ventilation	11
7.	Front Panel	12
7.1	Potentiometers settings	12
7.2	Indication LEDs	13
8.	Starting Procedure	13
8.1	Standard starting procedure	14
8.2	Examples of starting curves	15
9.	Technical Specifications	16

2. SAFETY & WARNINGS

2.1 Safety

	1	Read this manual carefully before operating the equipment and follow its instructions.
	2	Installation, operation and maintenance should be in strict accordance with this manual, national codes and good practice.
	3	Installation or operation not performed in strict accordance with these instructions will void manufacturer's warranty.
	4	Disconnect all power inputs before servicing the soft-starter and/or the motor.
	5	After installation, check and verify that no parts (bolts, washers, etc.) have fallen into the starter.
	6	During shipping, the soft-starter might have been roughly handled, therefore, it is recommended to initialize the soft-starter by connecting supply voltage prior to operating the soft-starter with a motor

2.2 Attention

	1	This product was designed for compliance with IEC 947-4-2 for class A equipment.
	2	Use of the product in domestic environments may cause radio interference, in which case, the user may be required to employ additional mitigation methods.
	3	Utilization category is AC-53a or AC53b, Form 1. For further information, see Technical Specification

2.3 Warnings

	1	Internal components and PCBs are at mains potential when the SOLSTART is connected to mains. This voltage is extremely dangerous and will cause death or severe injury if contacted.
	2	When SOLSTART is connected to mains, even if start command has not been issued and motor is stopped, full voltage appears on starter's output and motor's terminals. Therefore, for isolation purposes it is required to connect an isolation device upstream to the SOLSTART.
	3	The starter must be grounded (models Solstart 31A and up) to ensure correct operation, safety and to prevent damage.
	4	Check that Power Factor capacitors are not connected to the output side of the soft starter.
	5	Do not interchange line and load connections

The company reserves the right to make any improvements or modifications to its products without prior notice.

3. TECHNICAL DATA

3.1 Introduction

The SOLSTART electronic soft starter incorporates two sets of thyristors (Two phase control) to start a three-phase squirrel cage induction motor and an internal bypass.

By supplying a slowly increasing voltage, it provides soft start and smooth stepless acceleration, while drawing the minimum current necessary to start the motor.

A Soft Stop feature can be enabled when the Ramp-Down potentiometer is adjusted.

When used, upon stop signal, motor's voltage is slowly reduced to zero.

No control voltage is required to operate the SOLSTART.

3.2 Rating and frames sizes

SOLSTART model	FLC [A]	Dimensions WxHxD [mm]	Weight [kg]	EOA Relay	Aluminium case	Din rail mounting
SOLSTART 8	8	45x75x110	0.42	(-)	(-)	✓
SOLSTART 17	17	90x75x105	0.55	(-)	(-)	✓
SOLSTART 22	22	90x75x105	0.55	(-)	(-)	✓
SOLSTART 31	31	65x190x114	1.3	✓	✓	○
SOLSTART 44	44	65x190x114	1.3	✓	✓	○
SOLSTART 58	58	65x190x114	1.3	✓	✓	○

- Notes:**
- ✓ – Standard
 - ○ – Option
 - C – Consult factory
 - (-) – Not available
 - Refer to section 5 on page 9 for detailed dimensions.

3.3 Starter Selection

Select the starter according to motor's Full Load Ampere (FLA) - as indicated on its nameplate (even if the motor will not be fully loaded).

The SOLSTART is designed to operate under the following maximum conditions:

Ambient Temperature [°C]	Starting Current [A]	Acceleration Time [sec]
40	350% I_n	5

Max. starts per Hour: four (4) starts per hour at maximum ratings and up to 10 starts per hour at light load applications (consult factory).

Note:

For very frequent starts (inching applications) the inching current should be considered as the Full Load Current (FLC) (consult factory).

3.4 Mains and control description

3.4.1 Mains Voltage (line to line) (Terminals/bars L1, L2, L3)

Five mains voltage levels are available: 230V, 400V, 440, 480V, 600V.

Note:

230	220 - 240 Vac +10% -15%
400	380 - 415 Vac +10% -15%
440	440 Vac +10% -15%
480	460 - 500 Vac +10% -15%
600	575 - 600 Vac +10% -15%

3.4.2 Start/Stop (Terminals A1,A2)

Start/Stop command is initiated by closing/opening a voltage free contact (Dry contact)

Close: Start command.

Open: Stop command.

WARNING!	<u>Never apply voltage to terminals A1, A2.</u>
	Start/Stop with a maintained contact!
	When the line contactor is operated by a maintained contact, in case of Mains failure, the motor will be automatically restarted upon voltage restoration!

3.4.3 End Of Acceleration (terminals 3, 4) Solstart 31A and up

Voltage free, N.O., 5A / 250VAC, Solstart 31-58A

The contact closes after the time adjusted on the "Ramp-Up" potentiometer.

The contact returns to its original position on stop signal or upon voltage outage.

This contact can be used for:

- Activating a valve after a compressor has reached full speed.
- Activating a valve after a pump has reached full speed.
- Loading a conveyor after the motor has reached full speed.

3.5 Built-in Bypass

The SOLSTART incorporates two internal bypass relays allowing current flow through the thyristors only during starting process. At the end of the starting process, the built-in relays bypass the thyristors and carry the current to the motor.

When Ramp-Down potentiometer is set to allow soft-Stop process, upon stop command, the bypass relays will open immediately and the current will flow through the thyristors. The voltage will then be reduced slowly and smoothly to zero.

3.6 Starter selection tables for various voltage ratings.

1	The starter selection table below concern standard, 1500r.p.m. 50Hz, three-phase motors.
2	These values are given for guidance and may vary according to motor manufacturer and depending on the number of poles.
3	It is the user's responsibility to make sure that motor's FLA will never exceed Starter's FLC.

Starter model	Starter FLC [A]	Motor kW @230V [kW]	Motor kW @400V [kW]	Motor kW @480V [kW]	Motor kW @600V [kW]
SOLSTART 8	8	1.5	3	4	5.5
SOLSTART 17	17	4	8	9	12.5
SOLSTART 22	22	5.5	11	12.5	15
SOLSTART 31	31	8	15	18.5	25
SOLSTART 44	44	12.5	22	25	30
SOLSTART 58	58	15	25	37	45

3.6.1 Ordering Information

SOLSTART **31-** **400-** **0-** **S**
Full load **Mains** **Options** **Front**
Current **Voltage** **Panel**

Full load Current	
Specify	Description
Starter's FLC [A]	8 ⁽¹⁾ , 17 ⁽¹⁾ , 22 ⁽¹⁾ , 31, 44, 58

Mains Voltage	
Specify	Description
230	220 - 240 Vac +10% -15%
400	380 - 415 Vac +10% -15%
440	440 Vac +10% -15%
480	460 - 500 Vac +10% -15%
600	575 - 600 Vac +10% -15%

Options	
Specify	Description
0	No options
8	Harsh environment treatment
U	UL & cUL approval (Solstart 8-44A)
DRM	DIN rail mounting accessory. (models 31-58A.)
Notes:	<ul style="list-style-type: none"> For more than one option indicate, for example: 8+DRM (Harsh environment and DIN rail mounting accessory) Options must be factory installed.
Front Panel	
Specify	Description
S	Standard lexan

Notes:

⁽¹⁾ No End of Acceleration Relay in Solstart 8, 17, 22

Example:

SOLSTART rated 58A, mains voltage- 230V, harsh environment treatment and standard front panel:
SOLSTART 58 - 230 - 8 - S

4. RECOMMENDED WIRING SCHEMES

4.1 Typical wiring diagram

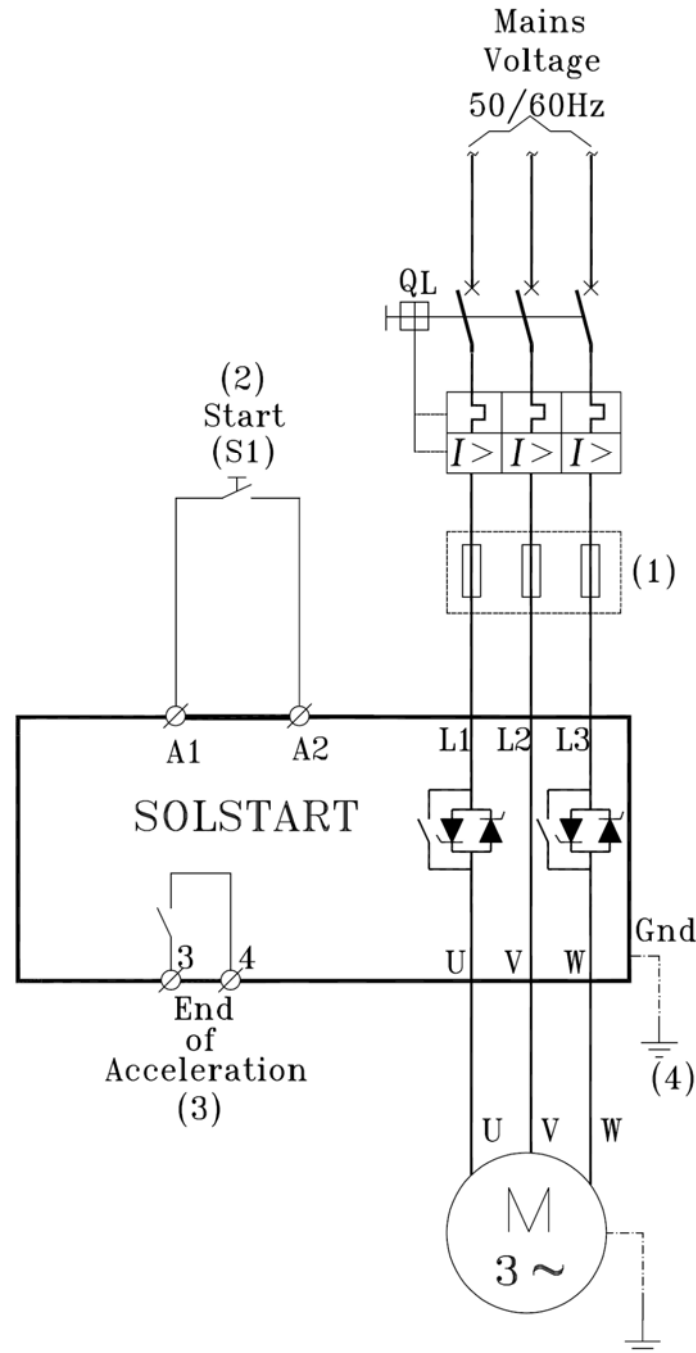

Notes:

- (1) - Use fuses for class 2 coordination. Refer to section 4.2.1 on page 8
- (2) – Use a maintained contact to start the motor. Open the contact to soft stop/stop the motor. Contact must be closed one second after voltage at L1, L2, L3 is stable.

Never apply voltage to terminals A1 & A2.

- (3) – End Of Acceleration contact is in SOLSTART 31A and up.
- (4) – Ground connection is in SOLSTART 31A and up.

4.2 Wiring Notes

WARNINGS!

When mains voltage is connected to the SOLSTART, full voltage appear on starter load terminals.

Therefore, for isolation purposes, it is necessary to connect an isolating device before the starter.

Power factor correction capacitors **must not** be installed on starters load side. When required, install capacitors on starter's line side.

Never connect the SOLSTART "Inside Delta"!

4.2.1 **Short Circuit Protection**

For “class 2 coordination”, protect the starter against a short circuit by thyristor protection fuses for I^2t as indicated in the following table:

SOLSTART type	I^2t (A ² S)
SOLSTART 8	400
SOLSTART 17	500
SOLSTART 22	560
SOLSTART 31	3000
SOLSTART 44	6,000
SOLSTART 58	12,000

4.2.2 **Transient Protection**

Line transient voltages can cause a malfunction of the starter and damage to the thyristors. All SOLSTART starters incorporate Metal Oxide Varistors (MOV) to protect from normal line voltage spikes.

When higher transients are expected, additional external protection should be used (consult factory).

5. DIMENSIONS

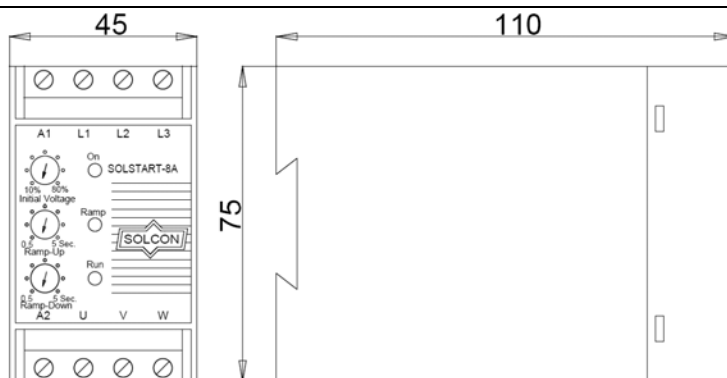

SOLSTART 8

Note: Mains voltage terminals: 4mm²

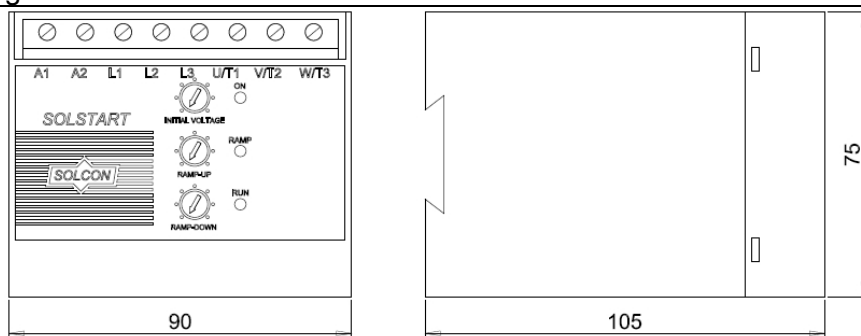

SOLSTART 17, 22

Note: Mains voltage terminals: 4mm²

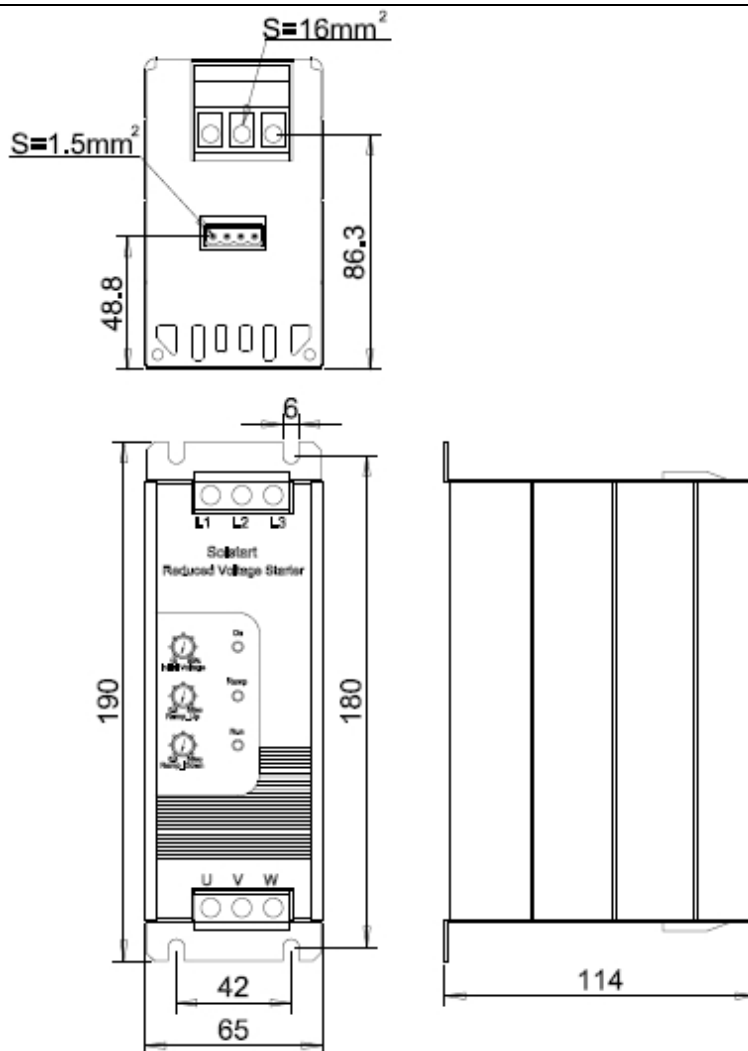

SOLSTART 31, 44, 58

6. INSTALLATION

WARNING!

Do not interchange line and load connections

Do not connect the SOLSTART "Inside Delta"

6.1 Prior to Installation

Check that Motor's Full Load Ampere (FLA) is lower than, or equal, to the starter's Full Load Current (FLC) and that Mains and Control voltages are as indicated on the starter's side label.



SOLSTART label - example

Make sure Starter's FLC ≥ Motor FLA!

Make sure Mains voltage is right!

Make sure control is by voltage free contact!

6.2 Mounting

The starter must be mounted vertically. Allow sufficient space (at least 100mm) above and below the starter for suitable airflow.

It is recommended to mount the starter directly on the rear metal plate for better heat dissipation.

Do not mount the starter near heat sources.

Surrounding air temperature in the cabinet should not exceed 40°C

Protect the starter from dust and corrosive atmospheres.

Note: For harsh environments (sewage treatment plants, etc.), it is recommended to order the starter with printed circuit board coating. Refer to section 3.6.1 on page 6 for ordering information.

6.3 Temperature range & heat dissipation

The starter is rated to operate over a temperature range of -10°C (14°F) to + 40°C (104°F).

Relative non-condensed humidity inside the enclosure should not exceed 95%.

ATTENTION!

Operating at surrounding air temp. (Inside the cabinet) higher than 40°C may cause damage to the starter.

Starter's heat dissipation while motor is running and the internal bypass relays are closed is typically less than $0.3 \times I_n$ (in watts). During soft start and soft stop, heating is approximately two times the actual starting current (I_n watts).

Example: For a 17A motor, heat dissipation is less than 5.1 watts while running.

Important note: If motor is frequently started, cabinet should be designed for the higher heat dissipation.

Internal enclosure heating can be reduced through the use of additional ventilation.

6.3.1 Calculating the enclosure size, for non-ventilated metallic enclosure

$$\text{Area (m}^2\text{)} = \frac{0.12 \times \text{Total heat dissipation [Watts]}}{60 - \text{External ambient temp. [}^\circ\text{C]}}$$

Where: **Area [m²]** - Surface area that can dissipate heat (front, sides, top).

Total heat dissipation [Watt] – The total heat dissipation of the starter and other control devices in the enclosure. If starter is frequently started, average power should be used.

6.3.2 **Additional Ventilation**

Use the following arrangement for forced ventilation of the SOLSTART's enclosure:

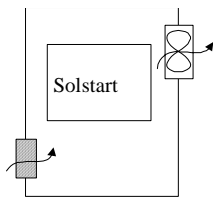

General purpose enclosure with filter on the air inlet and Fan on air outlet.

7. FRONT PANEL

The SOLSTART front panel contains:

- (1) Three potentiometers for setting: Initial Voltage, Ramp Up and Ramp Down.
- (2) Three indication LEDs: On, Ramp, Run.

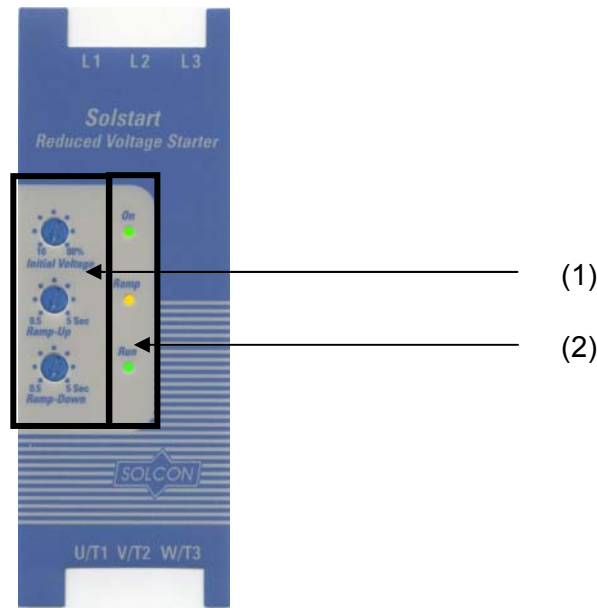

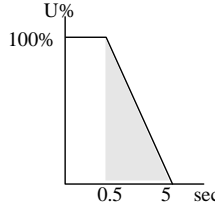

7.1 Potentiometers settings

Potentiometer	Range	Description
Initial Voltage	10-80%	<p>Determines the initial voltage to the motor (torque is directly proportional to the square of the voltage). This adjustment also determines the inrush current and mechanical shock. Too high of a setting may cause high initial mechanical shock and high inrush current. Too low of a setting may result in prolonged time until motor starts revolving. The motor should start revolving immediately after Start signal</p>
Ramp Up	0.5-5sec.	<p>Determines motor's voltage ramp-up time from initial to full voltage. It is recommended to set Ramp-Up Time to the minimum acceptable value.</p>

Potentiometer	Range	Description
Ramp Down	0.5-5 sec.	<p>Used to control deceleration of high friction loads. When Ramp-Down potentiometer is set, upon stop signal the starter output voltage is gradually ramped down.</p> <p>When "Ramp-down Time" is set to minimum, the motor will stop immediately.</p> 

7.2 Indication LEDs

	Green	<i>On</i>	Will lit when Mains voltage is connected to the starter.
	Yellow	<i>Ramp</i>	Will lit during soft start and soft stop process, indicating that motor supply voltage is ramping up or down.
	Green	<i>Run</i>	Will lit after completion of starting process, indicating that motor is receiving full voltage.

8. STARTING PROCEDURE

	1	When mains voltage is connected to the SOLSTART, full voltage appear on the starter load terminals. Therefore, for isolation purposes, it is necessary to connect an isolating device before (upstream) the starter.
	2	Power factor correction capacitors must not be installed on starters load side. When required, install capacitors on starter's line side.
	3	Before starting the motor verify its rotation direction. If needed, disconnect the rotor from the mechanical load and verify the right rotation direction.
	4	Prior to Start up procedure make sure that line voltage match the one shown on the starter's name plate.
	5	Do not interchange line and load connections
	6	Do not connect the SOLSTART "Inside delta".

8.1 Standard starting procedure

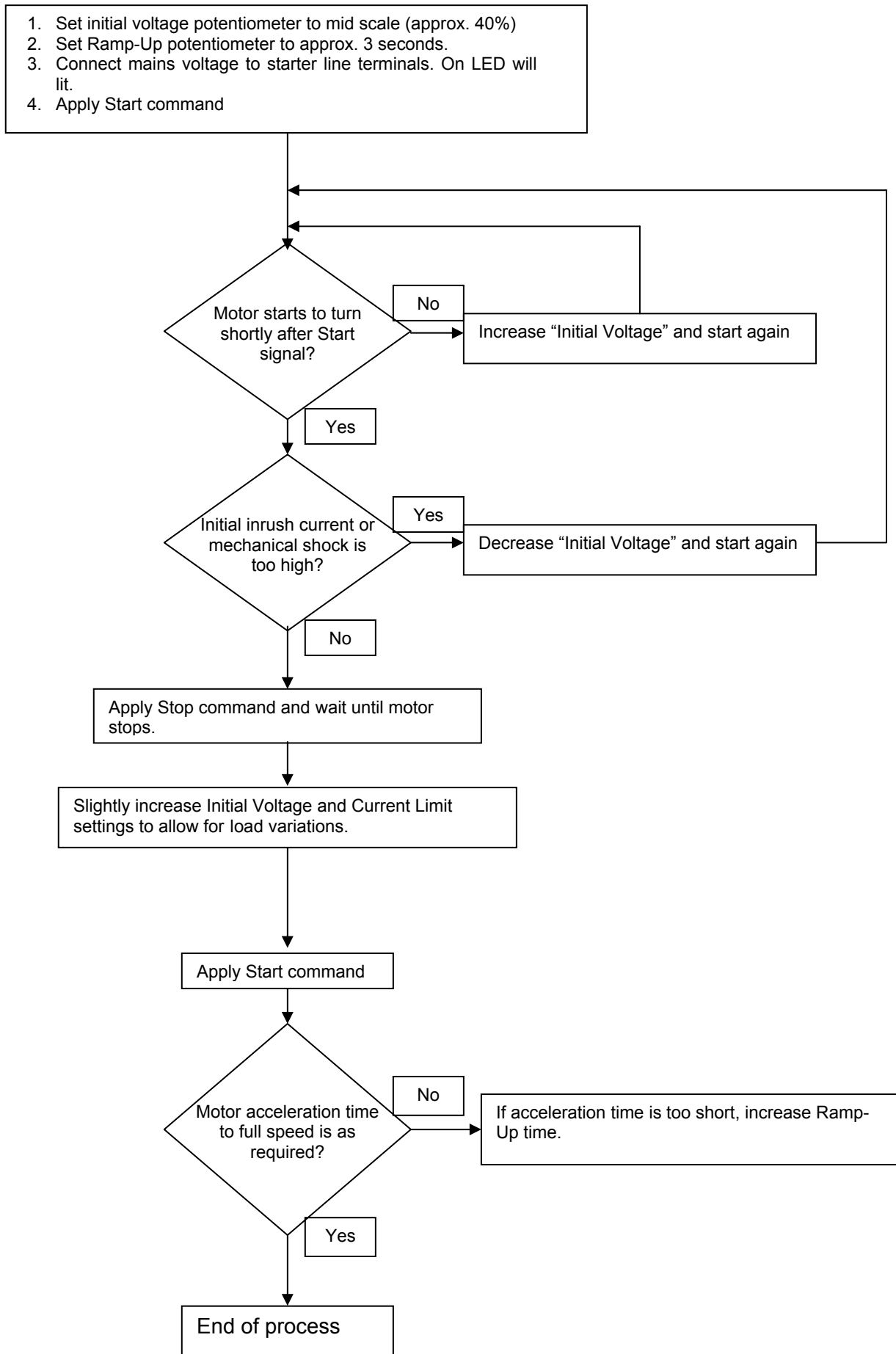

8.2 Examples of starting curves

Light loads - pumps, etc.

Initial Voltage - set to 40%

Ramp-up time - set to 3 sec.

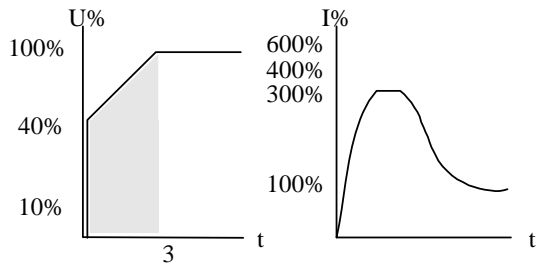

Upon start, the voltage quickly increases to the Initial Voltage value (40% U_n) and then gradually ramps-up to nominal.

The current will simultaneously increase to peak current value, before smoothly decreasing to the operating current. The motor will quickly and smoothly accelerate to full speed.

9. TECHNICAL SPECIFICATIONS

Environment		
Supply voltage	230 220 - 240 Vac +10% -15% 400 380 - 415 Vac +10% -15% 440 440 Vac +10% -15% 480 460 - 500 Vac +10% -15% 600 575 - 600 Vac +10% -15%	
Frequency	50 / 60 Hz	
Load	Three-Phase, Three-Wire, Squirrel Cage Induction Motor	
Degree of protection	SOLSTART 8-44A: IP 20 SOLSTART 58: IP 00	
Altitude	1000 m above sea level	Consult factory for derating
Adjustments		
Starting Torque (Initial Voltage)	10-80 % of full voltage	
Ramp Up Time (soft start)	0.5 - 5 sec.	
Ramp Down Time (Soft Stop)	0.5 - 5 sec.	
Indications		
Indication lights (LEDs)	ON - Green	Lights when mains is connected to the SOLSTART.
	Ramp Up / Ramp Down – Yellow	Lights during Ramp-Up and Ramp-Down
	RUN – Green	Lights upon end of starting. When the internal bypass relays close.
Temperatures		
Operating	-10° to 40°C	
Storage	-20° to 70°C	
Relative humidity	93 % - non condensed	
EMC		
Immunity to radio electric interference	EN 1000-4-3 level 3	Conforming to EN 60947-4-2
Electrostatic discharge	EN 1000-4-2 level 3	Conforming to EN 60947-4-2
Immunity to electrical transients	EN 1000-4-4 level 4	Conforming to EN 60947-4-2
Shock waves of voltage / current	EN 1000-4-5 level 3	Conforming to EN 60947-4-2
Radiated and conducted emissions	EN 1000-4-6 level 3	
Radio frequency emissions	According to EN 55011 class A	Conforming to EN 60947-4-2
Mechanical		
Shock resistance	8 gn	Conforming to EN 60947-4-2
Vibration resistance	2 gn	Conforming to EN 60947-4-2
Output relay (Solstart 31-58A only)		
End of Acceleration Contact	N.O.	
Rated operating current	5 A, 250 VAC - Solstart 31-58A	



Solcon Industries Ltd.

www.solcon.com; Technical support: office@solcon.com